

## Appendix A

# Problem Statements and Information Needs

2011 Draft Annual Technical Report

**SAN JOAQUIN RIVER**  
RESTORATION PROGRAM

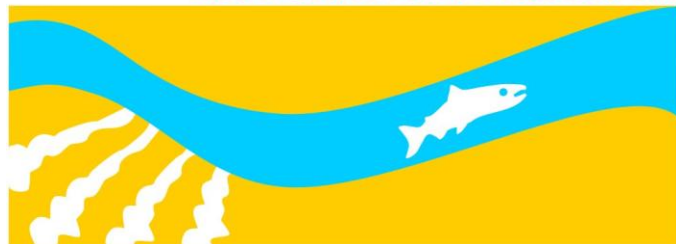



# Table of Contents

<b>1.0 Introduction .....</b>	<b>1</b>
<b>2.0 Problem Statement – Gravelly Ford Flow Targets .....</b>	<b>10</b>
<b>3.0 Problem Statement – Unexpected Seepage Losses Downstream from Gravelly Ford .....</b>	<b>17</b>
<b>4.0 Problem Statement – Seepage Management.....</b>	<b>21</b>
<b>5.0 Problem Statement – San Joaquin River Channel Capacity Management.....</b>	<b>29</b>
<b>6.0 Problem Statement – Mature Spawners.....</b>	<b>33</b>
<b>7.0 Problem Statement – Healthy Fry Production .....</b>	<b>35</b>
<b>8.0 Problem Statement –Smolt Outmigration .....</b>	<b>37</b>
<b>9.0 Problem Statement – Smolt Survival .....</b>	<b>41</b>
<b>10.0 Problem Statement – Adult Recruits.....</b>	<b>43</b>
<b>11.0 Problem Statement- Adult Passage .....</b>	<b>45</b>

**Tables**

Table A-1. Fisheries Life Stages, Physical Monitoring Parameters, and Studies .....	4
Table A-2. Typical Losses from Friant Dam to Gravelly Ford .....	11
Table A-3. Gravelly Ford Daily Adjustment Factors .....	12
Table A-4. Exhibit B Normal-Wet Year Assumptions.....	18
Table A-5. Capacities of San Joaquin River and Bypasses Within Restoration Area .....	<b>Error! Bookmark not defined.</b>

**Figures**

Figure A-1. Schedule of Monitoring and Reporting. **Error! Bookmark not defined.**

Figure A-2. Gravelly Ford Flow Target Analytical Framework .....11

Figure A-3. Seepage Evaluation Conceptual Model .....21

Figure A-7. Physical Monitoring Parameters and Biological Impacts that  
May Affect Mature Adult Spawning Spring-Run Chinook Salmon .....34

Figure A-8. Physical Monitoring Parameters and Biological Impacts that  
May Affect Successful Spawning and Ultimately Healthy Fry  
Production of Spring-Run Chinook Salmon.....36

Figure A-9. Physical Monitoring Parameters and Biological Impacts that  
May Affect Juvenile Spring-Run Chinook Salmon in San Joaquin  
River .....38

Figure A-10. Physical Monitoring Parameters and Biological Impacts that  
May Affect Survival of Migrating San Joaquin River Spring-Run  
Chinook Salmon Smolts .....42

Figure A-11. Physical Monitoring Parameters and Biological Impacts that  
May Affect Survival of Migrating San Joaquin River Spring-Run  
Chinook Salmon Adults.....45



# Abbreviations and Acronyms

Act	San Joaquin River Restoration Settlement Act
ADCP	Acoustic Doppler Current Profiler
ATR	Annual Technical Report
CDEC	California Data Exchange Center
cfs	cubic feet per second
CSUF	California State University, Fresno
CVP	Central Valley Project
CVRWQCB	Central Valley Regional Water Quality Control Board
CTK	Cottonwood Creek
Delta	Sacramento-San Joaquin Delta
DFG	California Department of Fish and Game
DO	dissolved oxygen
DPR	California Department of Pesticide Regulations
DWR	California Department of Water Resources
FMP	Fisheries Management Plan
FMWG	Fisheries Management Work Group
FWUA	Friant Water Users Authority
GBP	Grasslands Bypass Project
GIS	graphical information systems
GRF	Gravelly Ford
GPS	global positioning system
HEC-RAS	Hydrologic Engineering Centers River Analysis System
LDC	Little Dry Creek
mg	milligram
MIL	Millerton Lake gaging station
mm	millimeters
NAD	North American Datum
N/L	nitrogen per liter
NMFS	National Marine Fisheries Service
NRDC	Natural Resources Defense Council
Order	State Water Resources Control Board Order WR-2009-0058-DWR
PVC	polyvinyl chloride
QA/QC	quality assurance/quality control
RA	Restoration Administrator
Reclamation	U.S. Department of the Interior, Bureau of Reclamation

San Joaquin River Restoration Program  
2010 Annual Technical Report

RFID	radio frequency identification
RM	river mile
RTK	real-time kinematic
Secretary	Secretary of the U.S. Department of the Interior
Settlement	Stipulation of Settlement in NRDC, et al., v. Kirk Rodgers, et al.
SJR	San Joaquin River
SJRRP	San Joaquin River Restoration Program
SWAMP	Surface Water Ambient Monitoring Program
TMDL	total maximum daily load
USGS	U.S. Geological Survey
USFWS	U.S. Fish and Wildlife Service
WLR	water level recorder
WSE	water surface elevation
WY	Water Year



# 1.0 Introduction

This appendix presents a framework for developing studies to support the San Joaquin River Restoration Program (SJRRP). Problem statements describe monitoring and analysis requirements from the Stipulation of Settlement in *NRDC, et al., v. Kirk Rodgers, et al.* (Settlement), San Joaquin River Restoration Settlement Act (Act), and Draft Fisheries Management Plan (FMP), and are used to inform a long-term approach to address those needs through organized scientific studies and data collection. Problem statements presented in this appendix describe the current conceptual framework for how the SJRRP is currently approaching technical challenges.

Studies link components with Settlement, Act, and FMP requirements, demonstrate applicability to SJRRP implementation, justify expenditures, aid prioritization, and potentially facilitate identification of alternative approaches.

Compiling and prioritizing studies are necessary to develop an integrated monitoring and analysis approach, and assist with scheduling flow releases. The Restoration Flow Guidelines describe an annual process to develop plans, solicit feedback, implement monitoring plans, and report results. The process includes a planning period for the following spring and summer flows, a planning period for fall and winter flows, and periodic reporting. **Figure A-1** summarizes the process.

San Joaquin River Restoration Program  
2010 Annual Technical Report

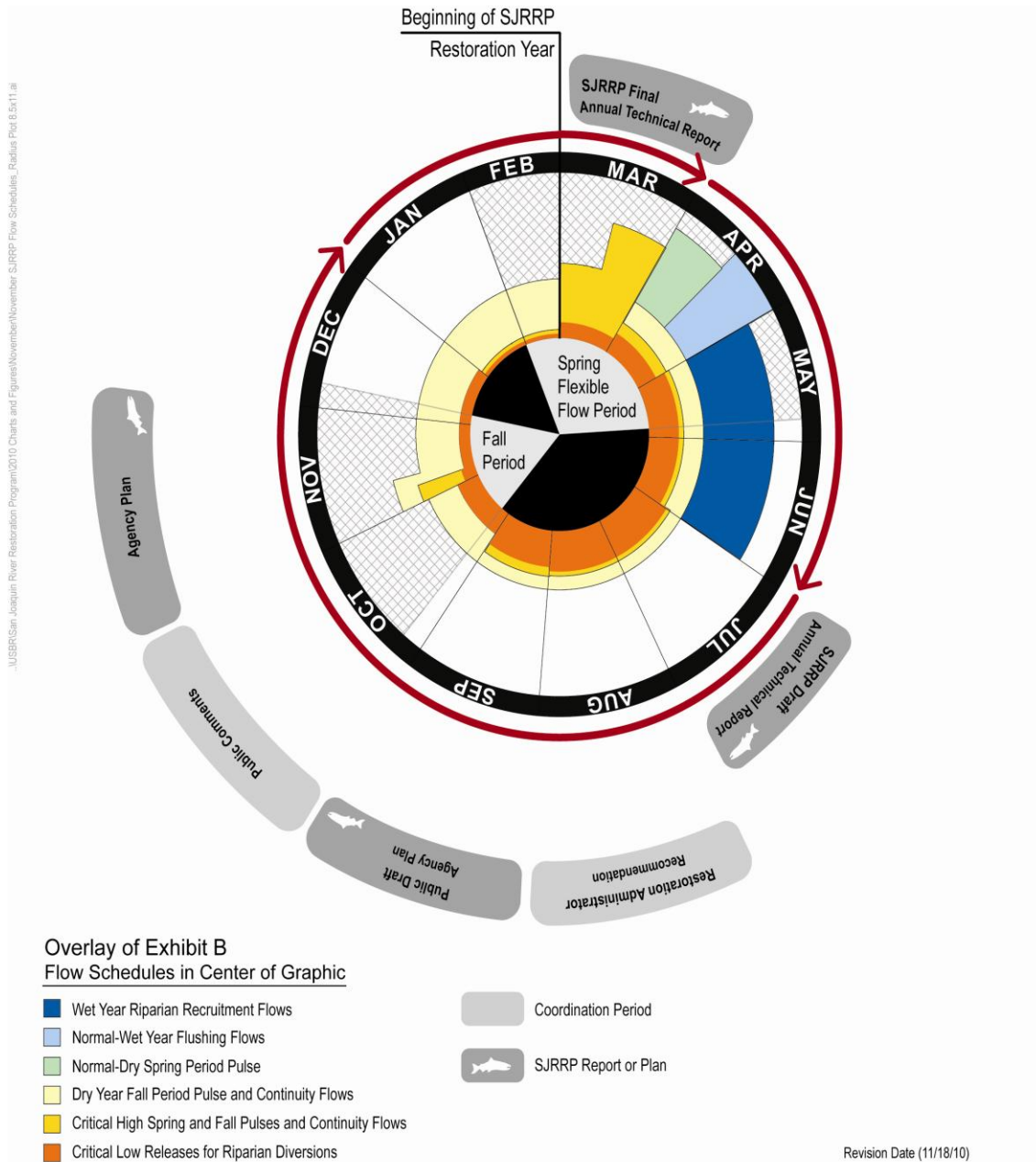

**Figure A-1. Schedule of Monitoring and Reporting**

Fisheries studies presented in this appendix may be applicable to multiple life stages, including:

- Adult Holding
- Spawning and Incubation
- Juvenile Rearing

- Smolt Migration
- Adult Migration

Table A-1 presents a summary of the different life stages, the physical monitoring parameters that may influence development and the ability for Chinook salmon to achieve the life stage outcome, and the studies that are related. Some studies are currently under development and not included in this appendix.

**Table A-1. Fisheries Life Stages, Physical Monitoring Parameters, and Studies**

<b>Life Stage</b>	<b>Life Stage Outcome</b>	<b>Physical Monitoring Parameters</b>	<b>Biological Need or Impact</b>	<b>Study</b>
Adult Holding	Mature Spawner	Water Temperature	Disease	Temperature Monitoring for Millerton Cold Water Pool
Adult Holding	Mature Spawner	Water Temperature	Disease, suitable habitat	In-river water temperature monitoring
Adult Holding	Mature Spawner	Holding Pool Habitat	Suitable habitat	Effect of Altered Flow Regime on Channel Morphology in Reach 1A
Adult Holding	Mature Spawner	Water Temperature	Disease, Prespawn mortality, in vitro egg mortality	Effect of Altered Flow Regime on Channel Morphology in Reach 1A
Adult Holding	Mature Spawner	Stream Flow	disease, suitable habitat	Meso-Habitat, Stream Flow Monitoring
Adult Holding	Mature Spawner	Harvest	number of spawners	Evaluation of Law Enforcement Needs and Regulatory Changes to Limit Harvest
Spawning and Incubation	Healthy Fry Production	Gravel Quantity	Suitable habitat, egg survival, emergence	Reach 1A Spawning Area Bed Mobility
Spawning and Incubation	Healthy Fry Production	Gravel Quantity	Suitable habitat, egg survival, emergence	Reach 1A Gravel Augmentation
Spawning and Incubation	Healthy Fry Production	Gravel Quantity	Suitable habitat, egg survival, emergence	Effect of Altered Flow Regime on Channel Morphology in Reach 1A
Spawning and Incubation	Healthy Fry Production	Gravel Quality	Suitable habitat, egg survival	Reach 1A Spawning Area Bed Mobility
Spawning and Incubation	Healthy Fry Production	Gravel Quality	Suitable habitat, egg survival, emergence	Reach 1A Mechanical Disturbance to Enhance Bed Mobility
Spawning and Incubation	Healthy Fry Production	Gravel Quality	Suitable habitat, egg survival, emergence, redd superimposition	Monitoring Spawning Gravel Quality and Quantity

**Table A-1. Fisheries Life Stages, Physical Monitoring Parameters, and Studies (contd.)**

<b>Life Stage</b>	<b>Life Stage Outcome</b>	<b>Physical Monitoring Parameters</b>	<b>Biological Need or Impact</b>	<b>Study</b>
Spawning and Incubation	Healthy Fry Production	Gravel Quality	egg survival, emergence	Effect of Scour and Deposition on Incubation Habitat in Reach 1A
Spawning and Incubation	Healthy Fry Production	Water Quality (dissolved oxygen)	egg survival, emergence	Water Quality Study
Spawning and Incubation	Healthy Fry Production	Gravel Quality	Suitable habitat	Effect of Altered Flow Regime on Channel Morphology in Reach 1A
Spawning and Incubation	Healthy Fry Production	Stream Flow	egg survival, emergence, redd superimposition	<i>Stream flow monitoring</i>
Spawning and Incubation	Healthy Fry Production	Intragravel Flow	Egg survival, emergence	<i>TBD</i>
Spawning and Incubation	Healthy Fry Production	Water Temperature	Egg survival, emergence	Temperature Monitoring for Millerton Cold Water Pool
Spawning and Incubation	Healthy Fry Production	Water Temperature	Egg survival, emergence	<i>In-river water temperature monitoring</i>
Juvenile Rearing	Smolt Outmigration	Water Temperature, Stream Flow, Meso-habitat	reach specific survival, migration timing, pathways	Juvenile Chinook Salmon Survival Study
Juvenile Rearing	Smolt Outmigration	Stream Flow, Structure Evaluation	migration delays, false pathways, physical harm	Entrainment
Juvenile Rearing	Smolt Outmigration	Floodplain Inundation	prey availability, predation	Floodplain Inundation
Juvenile Rearing	Smolt Outmigration	Water Quality (salts and toxins)	prey availability, disease	Water Quality Study, SWAMP Macroinvertebrate Bioassessment
Juvenile Rearing	Smolt Outmigration		predation	Predatory Study

**Table A-1. Fisheries Life Stages, Physical Monitoring Parameters, and Studies (contd.)**

Life Stage	Life Stage Outcome	Physical Monitoring Parameters	Biological Need or Impact	Study
Juvenile Rearing	Smolt Outmigration	Gravel Quality	suitable habitat availability	Effect of Altered Flow Regime on Channel Morphology in Reach 1A
Juvenile Rearing	Smolt Outmigration	Water Temperature	disease, suitable habitat availability, predation, prey availability	Temperature Monitoring for Millerton Cold Water Pool
Juvenile Rearing	Smolt Outmigration	Water Temperature	disease, suitable habitat availability, predation, prey availability	<i>In-river water temperature monitoring</i>
Smolt Migration	Smolt Survival	Water Temperature	disease, suitable habitat availability, predation, prey availability	Temperature Monitoring for Millerton Cold Water Pool
Smolt Migration	Smolt Survival	Water Temperature	disease, suitable habitat availability, predation, prey availability	<i>In-river water temperature monitoring</i>
Smolt Migration	Smolt Survival		migration delays, false pathways, physical harm	Entrainment
Smolt Migration	Smolt Survival	Floodplain Inundation	prey availability, predation	Floodplain Inundation
Smolt Migration	Smolt Survival	Water Quality (salts and toxins)	prey availability, disease	Water Quality Study, SWAMP Macroinvertebrate Bioassessment
Smolt Migration	Smolt Survival	Delta Outflow	prey availability	No study proposed
Smolt Migration	Smolt Survival	Harvest	smolt survival	Evaluation of Law Enforcement Needs and Regulatory Changes to Limit Harvest

**Table A-1. Fisheries Life Stages, Physical Monitoring Parameters, and Studies (contd.)**

Life Stage	Life Stage Outcome	Physical Monitoring Parameters	Biological Need or Impact	Study
Adult Recruits	Ocean Survival	Ocean productivity	prey availability, predation, disease	No study proposed
Adult Migration	Adult Passage	Water Temperature	Migration delays	Temperature Monitoring for Adult Migration
Adult Migration	Adult Passage	Stream Flow	straying	<i>Stream flow monitoring</i>
Adult Migration	Adult Passage	Barriers	straying, blocked passage	Fish Passage Evaluation.
Adult Migration	Adult Passage	Delta Outflow and Delta Water Quality	disease, delayed migration	No study proposed
Native Fish Assemblages	Healthy Communities	Water Temperature, Stream Flow, Meso-Habitat	suitable habitat availability to support native fish assemblages	Fish Community Assessment
All Life Stages	Successful Reintroduction		Genetics	Fall-run Chinook Experimental Captive Rearing Study
All Life Stages	Successful Reintroduction		Genetics	Natural Recolonization Study
All Life Stages	Successful Reintroduction		Genetics	Temperature Tolerance Study
All Life Stages	Successful Reintroduction		Genetics	Juvenile Chinook Predation Study
All Life Stages	Successful Reintroduction		Genetics	Positioning Central Valley Chinook single nucleotide polymorphisms onto the genetic map for Chinook salmon
All Life Stages	Successful Reintroduction		Genetics	Parentage based tagging (PBT)
All Life Stages	Successful Reintroduction		Genetics	Broodstock Genetic Diversity Study
All Life Stages	Successful Reintroduction		Genetics	Mating Matrix Development
All Life Stages	Successful		Genetics	Epigenetics Study: Comparison of Genetic Diversity and

**Table A-1. Fisheries Life Stages, Physical Monitoring Parameters, and Studies (contd.)**

Life Stage	Life Stage Outcome	Physical Monitoring Parameters	Biological Need or Impact	Study
	Reintroduction			Methylation Diversity of Spring-run broodstock
All Life Stages	Successful Reintroduction		Genetics	Salmon Egg Survival Study
All Life Stages	Successful Reintroduction		Genetics	Juvenile Chinook Salmon Migration Survival





## 2.0 Problem Statement – Gravelly Ford Flow Targets

*Account for riparian demands, tributary inflows and losses to identify the releases necessary to meet Gravelly Ford flow targets.*

The Settlement requires releases from Millerton Reservoir to meet flow targets along the San Joaquin River from Friant Dam to the confluence with the Merced River, as described in Paragraph 13 and Exhibit B. Before the Settlement, Friant Dam released water to the San Joaquin River to meet Riparian Holding contracts by achieving 5 cubic feet per second (cfs) of flow past Gravelly Ford. Releases from Friant Dam now include water for the SJRRP. The flow rates at the Gravelly Ford gage location represent additional releases above historical obligations of the Central Valley Project (CVP) Friant division.

Gravelly Ford is located 40 miles downstream from Friant Dam. After release of water, travel time, attenuation, tributaries, infiltration, diversions, and return flows outside direct control by the SJRRP influence flow rates in the San Joaquin River. Uncertainty of riparian diversion quantities is most significant during summer months when SJRRP has an objective to maintain river connectivity. Determination of the appropriate release requires an estimate of typical losses and adjustments for daily conditions. **Figure A-2** displays components used to estimate releases for meeting Gravelly Ford flow targets.

**Table A-2** reports the Settlement loss assumptions by flow rate and time of year.

2.0 Problem Statement – Gravelly Ford Flow Targets

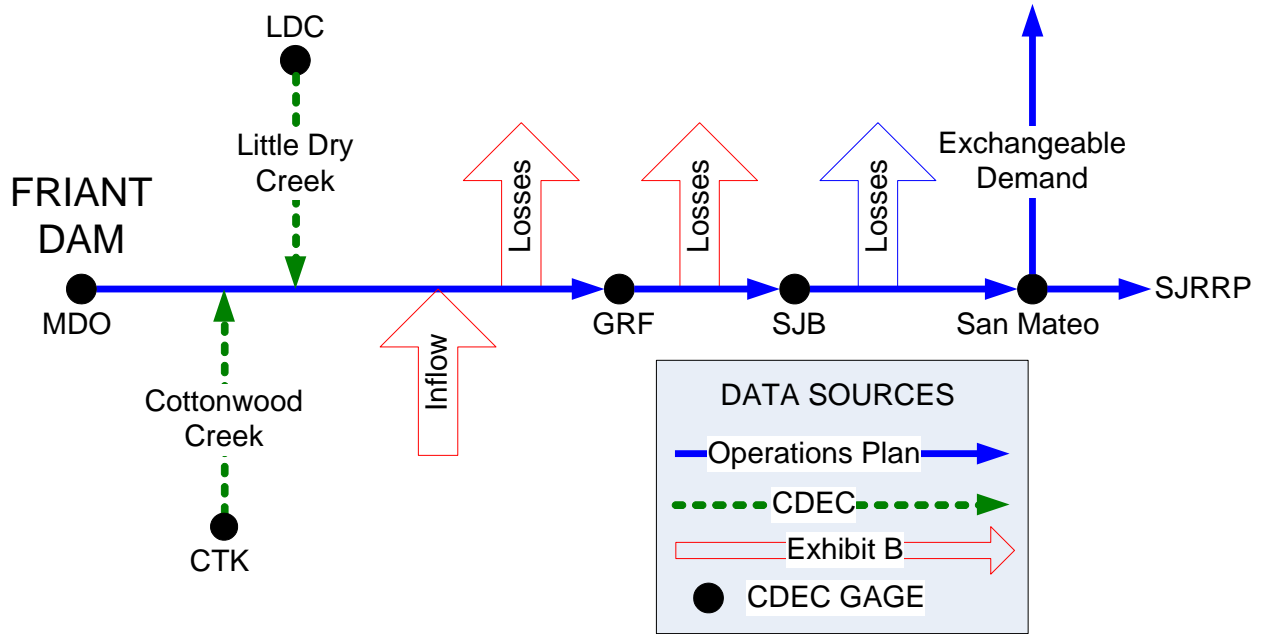

Note:  
 Inflows, losses, and exchangeable demand are measured in cubic feet per second (cfs)  
 Key:  
 CDEC = California Data Exchange Center  
 MDO = Millerton Daily Operations  
 CTK = Cottonwood Creek  
 GRF = Gravelly Ford  
 LDC = Little Dry Creek  
 SJB = San Joaquin River below Chowchilla Bifurcation Structure

**Figure A-2. Gravelly Ford Flow Target Analytical Framework**

**Table A-2. Typical Losses from Friant Dam to Gravelly Ford**

Time of Year	Reach 2 Losses (Exhibit B)	Reach 2 Losses (Actual)
October 1 – 31	80	Analysis in progress.
November 1 – 10	100	
November 11- December 31	80	
January 1 – February 28	80	
March 1 – 15	90	
March 16 – 31	150	
April 1 – 15	175	
April 16 – 30	200	
May 1 – June 30	80	
July 1 – August 31	80	
September 1 – September 30	80	

**Table A-2** will be updated based on analysis of Water Year (WY) 2010 flow gage records.

Table A-3 includes factors taken into consideration when reevaluating the Friant release. This analysis will improve understanding of applicability and limitations of telemetry data for real-time operations.

**Table A-3. Gravelly Ford Daily Adjustment Factors**

Friant Release Range (cfs)	MIL-GRF Travel Time (hours)	Tributary Travel Time (hours)	CDEC Accuracy (%)	Manual Streamflow Measurement Accuracy (%)
Analysis in progress.				

Key:

CDEC = California Data Exchange Center

MIL-GRF = Millerton Lake and Gravelly Ford gaging stations

## **2.1 Information Needs**

### **2.1.1 2010 Loss Estimates, Friant Dam to Gravelly Ford**

#### ***Statement of Need***

Typical losses for different flow rates and times of year inform decision-makers on flow releases from Friant Dam for meeting Gravelly Ford flow targets.

#### ***Background***

Exhibit B provides assumed losses to flow releases at Friant Dam to achieve Gravelly Ford flow targets. This study analyzes flow gage data gathered during WY 2010 releases.

#### ***Anticipated Outcomes***

Flow gage record analysis will yield an updated Table A-2. Recently observed flows form the basis for making flow release decisions at Friant Dam.

## **2.1.2 Tributary Influence of Gravelly Ford Flows**

### ***Statement of Need***

Tributary inflows change the loss assumptions from Friant Dam to Gravelly Ford.

### ***Background***

During precipitation events, tributaries to the San Joaquin River between Friant Dam and Gravelly Ford can produce large inflows of short duration. Reclamation's only mechanism to adjust flows reaching Gravelly Ford is the Friant Dam release. Existing California Data Exchange Center (CDEC) gages on Cottonwood Creek and Little Dry Creek provide real-time flow data from tributaries which contribute to Gravelly Ford flows.

### ***Anticipated Outcomes***

Table A-3 includes duration and magnitude estimates for tributary inflows. Operating rules for informing decisions to be made at Friant Dam are based on the influence of WY 2010 tributary inflows on Gravelly Ford flows.

### **2.1.3 Stabilization at Gravelly Ford**

#### ***Statement of Need***

Identify when the effects of Friant Dam flow changes will be evident at Gravelly Ford.

#### ***Background***

Friant Dam flow changes do not immediately affect flows at Gravelly Ford. Exhibit B reports all changes as occurring instantaneously.

#### ***Anticipated Outcomes***

Include in Table A-3 travel time for Friant releases and tributary inflows to stabilize at Gravelly Ford and allow reevaluation of Friant releases.

## **2.1.4 Variability in Measurements**

### ***Statement of Need***

Establish when measured flows at Gravelly Ford trigger a reevaluation of the Friant Dam release.

### ***Background***

Daily and weekly diversion practices in Reach 1, along with a measurement error, introduce a measure of uncertainty in attaining Gravelly Ford flow targets.

### ***Anticipated Outcomes***

Exceedence of a range of variability between measured and targeted flows at Gravelly Ford requires a reevaluation of the Friant Dam release.



### **3.0 Problem Statement – Unexpected Seepage Losses Downstream from Gravelly Ford**

*Identify unexpected seepage losses downstream from Gravelly Ford consistent with the guidelines in Settlement Paragraph 13(j), in accordance with Paragraphs 13 (c) (1) and 13(c) (2).*

The Settlement requires releases from Millerton Reservoir to meet flow targets along the San Joaquin River from Friant Dam to the confluence with the Merced River, as described in Paragraph 13 and Exhibit B. Exhibit B assumptions for flow targets downstream from Gravelly Ford include losses only in Reach 2A and accretions from Salt and Mud sloughs in Reach 5. If losses and diversions exceed Exhibit B assumptions, Paragraph 13(c) directs Reclamation to release water in accordance with the guidelines in Paragraph 13(j) such that the volume and timing of Restoration Flows are not impaired. Paragraph 13(c)(1) requires water to be acquired before commencement of full Restoration Flows, which the Secretary will use for additional releases. Paragraph 13(j)(iv) requires a methodology to determine whether losses or diversions exceed the levels assumed in Exhibit B before full Restoration Flows are released.

Short- or long-term changes in shallow groundwater conditions may result in differences between Exhibit B assumptions and actual observations, which will inform decisions on acquisition of water from willing sellers and releases to meet flow targets.

Reclamation will update the Exhibit B assumptions in Table A-4 with measured loss values for comparison with Exhibit B losses to inform water acquisition decisions.

**Table A-4. Exhibit B Normal-Wet Year Assumptions**

<b>Period of Time</b>	<b>Reach 2 Losses (cfs)</b>	<b>Salt and Mud Slough Accretions (cfs)</b>
October 1 – 31	80	300
November 1 – 10	100	300
November 11 – December 31	80	400
January 1 – February 28	80	500
March 1 – 15	90	500
March 16 – 31	150	475
April 1 – 15	175	400
April 16 – 30	200	400
May 1 – June 30	80	400
July 1 – August 31	80	275
September 1 – September 30	80	275

Key:  
cfs = cubic feet per second

## 3.1 Information Needs

### 3.1.1 2010 Loss Estimates, Below Gravelly Ford

#### ***Statement of Need***

Decisions to acquire and release additional water according to the guidelines in Paragraph 13(j) require an updated Table A-4 of measured losses.

#### ***Background***

Exhibit B specifies expected seepage losses below Gravelly Ford and includes provisions for Reclamation to acquire water from willing sellers if seepage below Gravelly Ford exceeds expectations, and to release water to meet flow targets downstream from Gravelly Ford.

#### ***Anticipated Outcomes***

Decisions on flow requirements and the potential for purchased water to meet downstream targets would rely on updated loss tables downstream from Gravelly Ford based on WY 2010 gage records.

*This page left blank intentionally.*

## 4.0 Problem Statement – Seepage Management

*Identify a relationship between San Joaquin River flow and groundwater levels to manage the potential for adverse impacts because of Restoration Flows, including both seepage and channel capacity limitations.*

Increases in flow in the river may cause groundwater levels to rise along the San Joaquin River and potentially waterlog crop roots or change the soil salinity profile. Public Law 111-11, Section 10004.h(3) and State Water Resources Control Board Order WR-2009-0058-DWR (Order) Provision 8 require a Seepage Monitoring and Management Plan. The plan includes both installing groundwater monitoring wells and establishing groundwater elevation thresholds to reduce or avoid impacts to agricultural lands or levee stability.

Flow release decisions at Friant and Mendota Dams rely on coarse assumptions about relationships between river stage, monitoring well readings, and groundwater elevations below fields. Management evaluation of potential seepage impacts is triggered by exceedence of monitoring thresholds based on the most recent crop rooting depth, salinity tolerance, and terrain information.

Monitoring both surface water stage and groundwater level in wells at Gravelly Ford and downstream quantifies a relationship between river stage and groundwater. Predictions of groundwater rise from calculated stage-flow rating curves assume a conservative direct connection between river stage and groundwater levels (see Figure A-3).

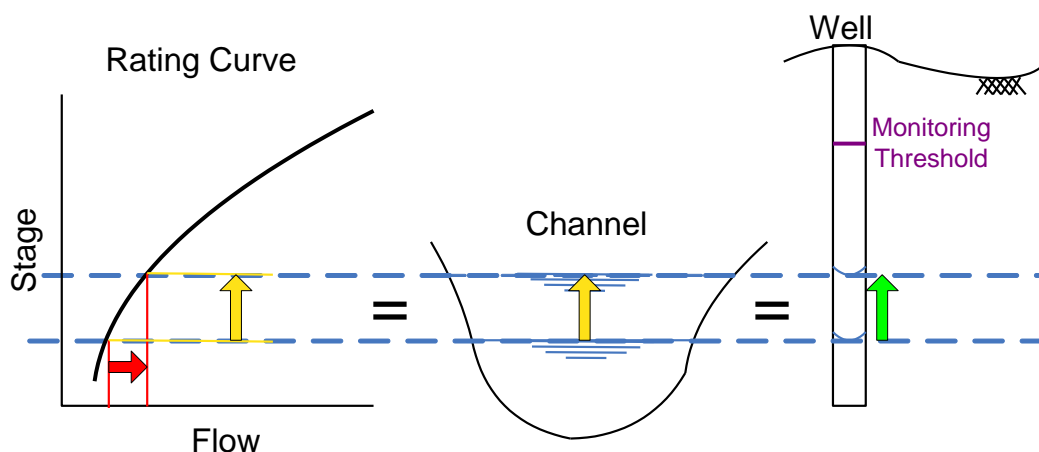

**Figure A-3. Seepage Evaluation Conceptual Model**

The flow bench evaluation process uses these groundwater predictions to determine the maximum allowable groundwater rise without encroachment into the buffer zone. When

flows exceed 475 cfs in Reaches 2A and 3, daily evaluations consider conveyance thresholds, Mendota Pool operational concerns, real-time and manual groundwater monitoring, upstream conditions, and seepage hotline calls to determine if seepage problems are anticipated and if Interim Flows must diverge from the recommended schedule. The daily evaluation process receives key input from the hotline calls, which usually prompt a site evaluation by Reclamation staff. Information gathered during the evaluation informs the flow scheduling process.

Site evaluations during Interim Flows determine if crop rooting depth and salinity tolerance are reflected by the established thresholds.

## 4.1 Information Needs

### 4.1.1 Lateral Gradient of Water Table

#### ***Statement of Need***

Relationships between surface water flow in the San Joaquin River and the associated near-river, shallow groundwater responses inform water management decisions regarding the magnitude, duration, and routing of SJRRP Interim Flows in the study area.

#### ***Background***

Groundwater and surface water monitoring currently informs real-time management of Interim Flows. Management decisions regarding the magnitude, duration, and routing of SJRRP Interim Flows benefit from evaluations of potential impacts to farm lands, subsurface drainage systems, and levees adjacent to the San Joaquin River. Currently, the primary metric to evaluate impacts is depth to groundwater from the land surface for lands adjacent to the river. A better understanding of the relationship between flows in the San Joaquin River, and the associated response in the shallow groundwater system, will allow SJRRP management to make informed real-time management decisions, and informed decisions regarding seepage mitigation actions should they be required.

The current working hypothesis for Interim Flows management decisions is a 1:1 relationship between river stage changes and the response in the shallow groundwater system adjacent to the river. Implicit in this assumption is a direct hydraulic connection between the river and the near-river aquifer, the absence of a groundwater gradient (slope) near the river, and the river as the sole influence on shallow groundwater levels beneath the lands adjacent to the river.

#### ***Anticipated Outcomes***

This investigation quantifies the response of the shallow groundwater to the Spring 2010 Interim Flows in the study area, evaluates the current working hypothesis used in the SJRRP flow bench evaluations, and informs future decisions regarding management of SJRRP Interim Flows and seepage mitigation actions should they be required.

#### **4.1.2 Terrain Comparison Between Wells and Fields**

##### ***Statement of Need***

Current operations assume the location of a monitoring well represents water table depth below ground surface in adjacent lands. Consideration of topography in threshold elevations accounts for site-specific conditions where wells cannot be placed in critical locations.

##### ***Background***

Specific buffer zones and thresholds trigger monitoring actions for each monitoring well. During 2010 Interim Flows, when groundwater exceeded a monitoring threshold, Reclamation conducted an evaluation of adjacent fields to determine if damage to crops was imminent, often at the request of landowners. Several thresholds proved to be non-representative of field conditions because of monitoring well placement on levee embankments. A refined approach allows Reclamation to more efficiently manage for seepage impacts.

##### ***Anticipated Outcomes***

Monitoring thresholds for wells may be updated because of an elevation differential between fields and monitoring wells outside the fields to ensure appropriate thresholds for nearby crops and prevent unnecessary use of resources in areas where seepage impacts are not imminent.



### **4.1.3 Changes in Salinity Conditions Resulting from Interim Flows**

#### ***Statement of Need***

Establish baseline salinity levels for seepage-prone areas to detect salinity changes resulting from Interim Flows. Quantify salinity changes over time from an established salinity baseline, rather than assuming by default, the presence of shallow groundwater during Interim Flows caused salinity impacts.

#### ***Background***

The primary adverse seepage impact to crops is mobilization of salts upward into the root zone.

#### ***Anticipated Outcomes***

Quantifying antecedent soil salinity conditions allows Reclamation to assess changes in salinity during Interim Flows. Repeated monitoring of soil salinity at locations with existing groundwater monitoring wells allows Reclamation to determine changes in soil salinity and potentially eliminate constraints to the release of flows when unnecessary.

#### **4.1.4 Flow Restrictions Due to Seasonal Groundwater Conditions**

##### ***Statement of Need***

Identify flow constrictions due to potential seepage impacts and prioritize sites for capacity-increasing solutions in the interest of conveying Restoration flows.

##### ***Background***

During WY 2010 Interim Flows, several locations experienced high groundwater levels and the potential for seepage impacts under higher flows. Based on the seepage management goal to reduce or avoid seepage impacts, these locations restricted flow releases for a given reach.

##### ***Anticipated Outcome***

This study refines assumptions about the river stage - seepage relationship, inventories known drainage infrastructure such as tile drains, develops conveyance solutions, and enables projection of capacity benefits following removal of each restriction.

#### **4.1.5 Monitoring Well Network Optimization**

##### ***Statement of Need***

Monitoring wells provide the basis for implementing the seepage management plan.

##### ***Background***

Groundwater data are needed to identify the gradient of the water table (Study 4.1) and to identify losses (Problem Statement 3). The existing well network has been expanded in response to landowner requests and to improve the data resolution available to inform decisions.

##### ***Anticipated Outcome***

Develop an updated monitoring well table.

*This page left blank intentionally.*

## **5.0 Problem Statement – San Joaquin River Channel Capacity Management**

*Identifying non-damaging flow capacities of the San Joaquin River to convey appropriate Interim Flows.*

Section 10004, Paragraph (h)(2)(B) of the Act authorizes the Secretary of the U.S. Department of the Interior to release Interim Flows to the extent that such flows do not exceed existing downstream channel capacities. Paragraph 13 of the Settlement states that releases of water from Friant Dam to the confluence of the Merced River shall be made to achieve the Restoration Goal, in accordance with hydrographs in Exhibit B (“Base Flows”) plus releases of up to an additional 10m percent of the applicable hydrograph flows (“Buffer Flows”). Under Exhibit B, the Friant Dam release includes up to 4,000cfs for Full Restoration Flows.

Friant Dam releases are based on estimates of non-damaging channel capacity from studies and model runs, as shown in Table 1, and conveyance requirements to deliver non-SJRRP water to satisfy existing contracts. Reach 3 is required to convey deliveries to San Luis Canal Company; this reduces the available capacity for Interim Flows. In addition, Reach 1 is required to convey deliveries for historical Riparian Holding Contracts of the Friant Division, although the large Reach 1 capacity means this is not a constraint on Interim Flow releases. Spring 2010 Interim Flow releases were designed conservatively to not surpass 8,000cfs in Reach 2A, or 1,300cfs in Reaches 2B or 3.

**Table 1. Capacities of San Joaquin River and Bypasses Within Restoration Area**

	<b>Reach</b>	<b>Upstream Extent</b>	<b>Downstream Extent</b>	<b>Design Capacity (cfs)</b>	<b>Approximate Non-Damaging Flow Capacity (cfs)</b>
<b>San Joaquin River</b>	1A	Friant Dam	State Route 99	8,000	NA
	1B	State Route 99	Gravelly Ford	8,000	NA
	2A	Gravelly Ford	Chowchilla Bypass Bifurcation Structure	8,000	8,000
	2B	Chowchilla Bypass Bifurcation Structure	Mendota Dam	2,500	1,300
	3	Mendota Dam	Sack Dam	4,500	1,300
	4A	Sack Dam	Sand Slough Control Structure	4,500	3,300
	4B1	Sand Slough Control Structure	Confluence with Mariposa Bypass	1,500	<100
	4B2	Confluence with Mariposa Bypass	Confluence with Bear Creek and Eastside Bypass	10,000	NA
	5	Confluence with Bear Creek and Eastside Bypass	Confluence with Merced River	26,000	NA
<b>Chowchilla Bypass</b>		Chowchilla Bypass Bifurcation Structure	Confluence with Fresno River and Eastside Bypass	5,500	NA
<b>Eastside Bypass</b>	1	Fresno River	Sand Slough Bypass	10,000-17,000	NA
	2	Sand Slough Bypass	Mariposa Bypass Bifurcation Structure/Eastside Bypass Bifurcation Structure	16,500	NA
	3	Mariposa Bypass Bifurcation Structure/Eastside Bypass Bifurcation Structure	Head of Reach 5	13,500-18,500	NA
<b>Sand Slough Bypass</b>		Sand Slough Control Structure	Eastside Bypass	3,000	
<b>Mariposa Bypass</b>		Mariposa Bypass Bifurcation Structure	Confluence with San Joaquin River	8,500	
<b>Kings River North</b>		Fresno Slough Bypass	Mendota Pool	4,750	

Key:  
cfs = cubic feet per second  
NA = not applicable

Planning and design of projects described in Paragraph 11 of the Settlement and implementation of Restoration Flows under Paragraph 13 of the Settlement require continued study of channel capacity.

Flows released according to capacity estimates greater than actual capacity could potentially exceed non-damaging channel capacity and impact adjacent lands. Flow schedules avoid potentially damaging conditions by relying on monitoring results from previous releases and refined hydraulic models.

## **5.1 Information Need: Improved Hydraulic & Sediment Models**

Flows released out of Friant Dam that exceed non-damaging channel capacity could impact adjacent lands. Restoration flow schedules avoid potentially damaging conditions by relying on monitoring results from previous releases and refined hydraulic models. In addition, the refined models will help managers predict impacts of proposed actions.

Channel responses to Restoration releases, such as inundation levels, channel capacity, flow timing, and sediment movement responses, require knowledge of hydraulic and sediment conditions along the reach. Hydraulic and sediment data are compared to model results, and adjustments are made to the models, as necessary, to better match the data.

In order to improve hydraulic and sediment models of the river, several areas of information were identified as necessary. As a result, five studies (including eight primary data collection needs) were implemented. They are as follows:

- Water Surface Elevations for Hydraulic Model Calibration
  - Water Surface Surveys
  - Discharge Measurements
- Water Level Recorders for Routing Model Calibration
  - Transducer installation and recorder download
- Sand Mobilization Effects on Water Surface Elevation
  - Profile Bed Surveys
  - Scour Chains
- Sand Storage in Reach 1
  - Sand Storage Assessment Surveys
- Bed Aggradation/Degradation
  - Topographic Monitoring Sections
  - Bed Sampling

## 5.2 Data Needs

### Hydraulic Models

Permanent gauging stations currently exist at control locations and some bridge sites providing discharge information needed to route flows through the system. While these keep a record of water surface elevations and calculated discharge, there are not enough of them to allow a detailed understanding of the river under varying flow conditions. Without measurements in addition to established gage locations, the level of confidence would be lower than required for quality calibration of hydraulic models.

Another identified question relates to how established hydraulic models represent sand bed streams. High flows in sand bed reaches may mobilize the bed to the extent that channel capacity is affected. Current rigid-boundary hydraulic models do not account for this effect, so confirmation of it would help managers interpret model results with respect to observations.

The following are specific data needs for improving the calibration of hydraulic models so that channel capacities can be better predicted:

- water surface elevation measurements at approximately 0.5-mile intervals during various levels of Restoration releases
- discharge measurements at approximately 5-mile intervals that can be correlated with concurrent water surface elevations
- installation of additional water-level recorders (transducers)
- channel bed profiling during events
- scour chain monitoring between events

### Sediment Models

Long term changes in the sand bed reaches due to restoration flows may include aggradation, degradation, meander migration, and other effects that may influence channel capacity.

Data needs identified that will improve understanding of current processes in the river, as well as help managers predict future changes, include:

- location and volume of primary supply sand deposits
- characteristics of sand-trapping in-channel pits
- monitoring sand bed reach topography between events
- sand bed sampling between events



## 6.0 Problem Statement – Mature Spawners

*Identify limiting factors to promote mature spawner development leading to a self-sustaining Chinook salmon population.*

Following the construction of Friant Dam, spring-run Chinook salmon continued to use several holding pools immediately downstream from the dam, until their eventual extirpation. A key life stage for spring-run Chinook salmon is adult holding for several months in deep, cold pools at the headwaters of their spawning system (immediately downstream from Friant Dam). Adult spring-run start to spawn as fall-run Chinook are migrating upstream and starting their spawning activities.

Unsuitable water temperature, limited suitable habitat availability, and illegal harvest are the key impacts, related to migrating, holding and spawning Chinook salmon that the SJRRP can monitor. Unsuitable water temperatures can lead to disease, prevent holding adults from developing into mature spawners, limit holding pool fish capacity, and increase vulnerability to illegal harvest (see Figure A-7). Meso-habitat corresponds to the quantity and variety of habitat units, the quantity and location of available holding pools, and the approximate total area of holding habitat encountered in Reach 1A (further analyses will be needed to address the quality of these habitats and potential for habitat beyond Reach 1A). FMWG thinks that law enforcement is the key to measuring impacts of illegal harvest of holding adults. Table A-1 lists the studies associated with Mature Spawners.

The conceptual models created by the FMWG for the FMP are more detailed than needed to define the monitoring programs that will be implemented by the SJRRP. Figure A-7 (and subsequent figures) are consistent with the conceptual models presented in the FMP, but are simplified to identify the physical parameters affecting mature spawners that can be monitored by the SJRRP.

## Adult Holding

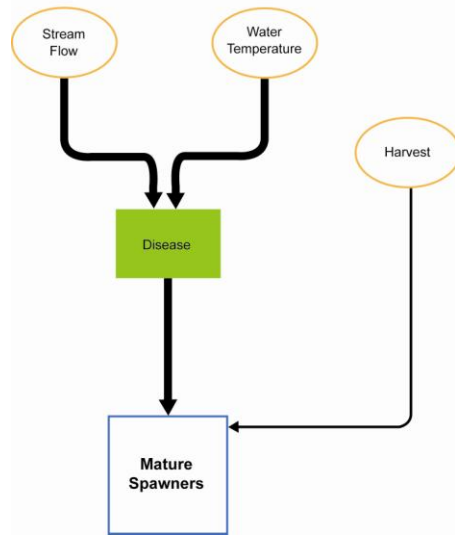

**Figure A-7. Physical Monitoring Parameters and Biological Impacts that May Affect Mature Adult Spawning Spring-Run Chinook Salmon**

A key limiting factor for holding adults in the San Joaquin River is water temperature. In general, water temperature is a function of release temperature, release rate, meteorological factors (e.g. ambient air temperature, albedo, solar radiation, wind speed, etc.), and duration of heat exchange, although the effects of warm summer air temperatures are minimal in the holding pools immediately downstream of Friant Dam because of the short duration of exposure to the surrounding environment. Water temperature in holding habitat is influenced by the level of the cold water pool in Millerton Lake and discharge from Friant Dam, and the SJRRP has the greatest control over river water temperature in adult holding habitat through cold water pool management in Millerton Lake. Unsuitable water temperature can lead to an increase in disease in adult fish and inadequate flows can reduce the amount of available habitat. Another limiting factor for holding adults is exposure to illegal harvest which would directly reduce the number of potential spawners. An evaluation of law enforcement needs to limit poaching in spawning areas to facilitate meeting adult fish targets is not currently underway, but would be necessary to determine the potential impact of excessive harvest on development of mature spawners.

Temperature data, and modeling calibrated with existing data and verified by continued monitoring will inform the RA flow schedule recommendations.

## 7.0 Problem Statement – Healthy Fry Production

*Identify limiting factors to healthy fry production, leading to a self-sustaining Chinook salmon population.*

To achieve the Restoration Goal, the SJRRP must reintroduce Chinook salmon that develop into a self-sustaining population. A key step to self-sufficiency is the production of fry from adults that spawn naturally in the river. The FMP identifies healthy fry production as the successful outcome of the spawning and incubation life stage. SJRRP thinks that spawner abundance, number of eggs, egg survival, emergence, interbreeding between spring-run and fall-run Chinook salmon, and redd superimposition are biological impacts to healthy fry production. SJRRP does not recognize any measureable biological impacts before reintroduction that affect healthy fry production.

SJRRP classifies gravel quantity, intragravel flows, dissolved oxygen (DO), water temperature, and streamflow as measureable physical impacts affecting healthy fry production. These impacts are understood to control conditions in gravel and the hyporheic zone necessary to support a successful adult spawning and egg incubation life stage. SJRRP will make use of riverbed monitoring data and biological data following reintroduction to manage for conditions favoring healthy fry production.

The conceptual models created by the FMWG for the FMP are more detailed than is needed to define the monitoring programs that will be implemented by the SJRRP. Figure A-8 is consistent with the conceptual models presented in the FMP, but is simplified to identify the physical parameters affecting healthy fry production that may be monitored by the SJRRP. Table A-1 lists the studies associated with Healthy Fry Production.

## Spawning and Incubation

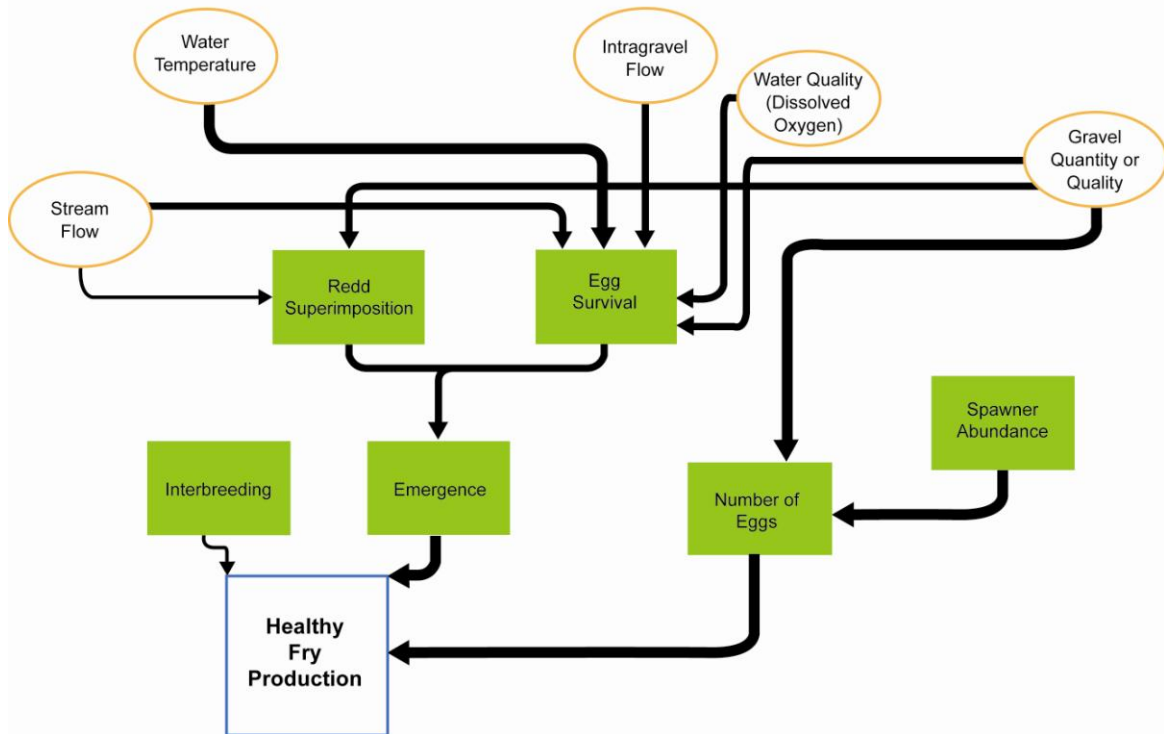

Note: The width of the arrows indicates the relative importance of each mechanism.

**Figure A-8. Physical Monitoring Parameters and Biological Impacts that May Affect Successful Spawning and Ultimately Healthy Fry Production of Spring-Run Chinook Salmon**

Successful spawning and incubation will lead to successful fry production in the San Joaquin River, which will help achieve a self-sustaining spring-run Chinook salmon population. Physical parameters that can be monitored that have the greatest effect on egg survival and development include spawning gravel quantity and quality (including DO and intragravel flow) and streamflow. Low gravel quantity could result in increased redd superimposition, reduced number of eggs (both because of reduced available spawning habitat), and thus reduced egg survival. Poor gravel quality includes embedded and immobile gravels, which prevent flushing of the matrix material thereby reducing intragravel flow, increasing difficulty for redd construction, and reducing emergence success could result in decreased fry production.

## 8.0 Problem Statement –Smolt Outmigration

*Identify limiting factors influencing juvenile rearing and smolt outmigration that affect a self-sustaining Chinook salmon population.*

A self-sustaining Chinook salmon population requires favorable habitat conditions in the upper reaches of the Restoration Area for rearing, smoltification, and outmigration before seasonal passage conditions deteriorate and prevent migration. Biological impacts that affect rearing and outmigration include entrainment, prey availability, predation, and disease. The SJRRP considers salinity, toxins, floodplain inundation, water quality, and water temperature as measurable, physical impacts, and prey availability as a measureable biological impact to development of smolt outmigrants. Monitoring data from these impacts informs decisions for managing conditions supporting rearing and smolt outmigrants. Table A-1 lists the studies associated with Smolt Outmigration.

Figure A-9 is consistent with the conceptual model for juvenile rearing presented in the FMP, but is simplified to identify the physical parameters affecting these life stages that will be monitored through the SJRRP. Some of the biological impacts (i.e., predation, prey availability and entrainment) can be monitored with the physical parameters, and are proposed by the FMWG for this life stage. Channel morphology, directly related to flow regimes, can affect the quantity and quality of available habitat for each life stage of Chinook salmon. Changes in channel morphology could have implications to the survival of each life stage.

## Juvenile Rearing

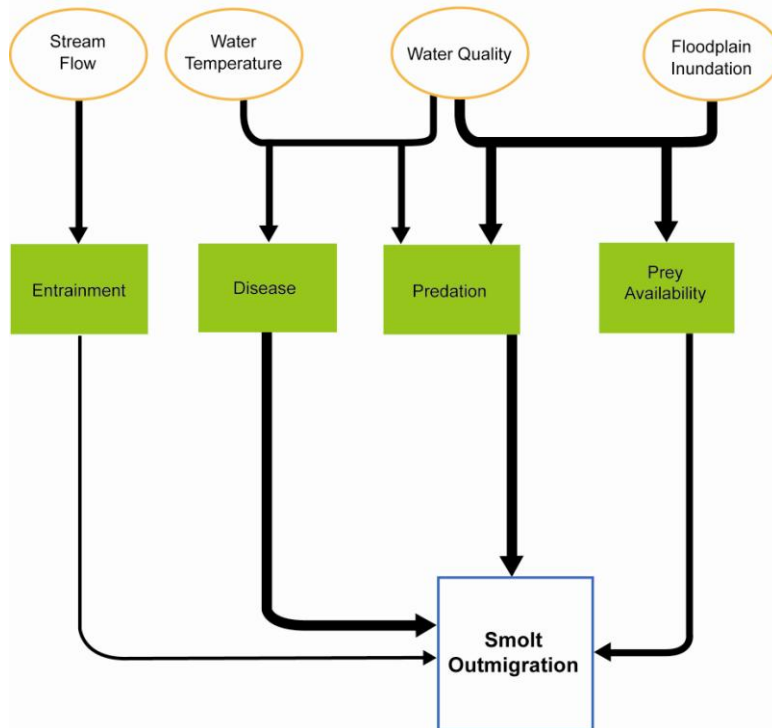

Note: The width of the arrows indicates the relative importance of each mechanism.

**Figure A-9. Physical Monitoring Parameters and Biological Impacts that May Affect Juvenile Spring-Run Chinook Salmon in San Joaquin River**

Water temperature and degraded water quality can affect the level of disease exposure, amount of available prey, and predation intensity on juvenile fish. Often, predatory species are more active in warmer waters and can tolerate poorer water quality conditions; thus, having increased water temperatures and degraded water quality can create an environment more conducive to predation.

The use of floodplain habitat by juvenile Chinook salmon as they move downstream has been found to be extremely important for growth, development, and survival. Food resources tend to be much greater in newly inundated floodplains, particularly if the floodplain remains inundated for at least 2 weeks, and growth rates accelerated. Larger fish migrating downstream tend to have increased survival rates.

Determining invertebrate prey composition and abundance in the major rearing habitats (e.g., floodplain, edgewater, backwater) identified in Reach 1A is necessary to understand the potential for survival and growth of smolt outmigrants. Future surveys would need to be completed to evaluate floodplain and riparian habitats, and to determine invertebrate prey composition and abundance in rearing habitats. Current bioassessment surveys evaluate benthic macroinvertebrate composition and abundance in Reaches 1 through 5 of the mainstem San Joaquin River. Entrainment at structures in the river can result in reduced juvenile survival. It is important to evaluate structures for loss of fish due to

entrainment, or decreased survival due to injury in order to determine if improvements need to be made.

*This page left blank intentionally.*



## 9.0 Problem Statement – Smolt Survival

*Identify limiting factors to smolt survival leading to a self-sustaining Chinook salmon population.*

The FMP identifies smolt survival as the outcome of the Smolt Migration life stage. Juveniles that develop into smolt outmigrants must survive migration to the ocean. Biological impacts to smolt survival include predation, prey availability, entrainment, and disease. The SJRRP considers water temperature, water quality, floodplain inundation, salinity, and toxins to be measureable, physical impacts, and prey availability and predator populations to be measureable, biological impacts to smolt survival. Delta outflow is a physical impact to smolt survival, but is not part of the SJRRP monitoring program. SJRRP monitoring data and data from outside sources regarding these impacts inform decisions to manage for conditions supporting smolt survival.

Figure A-10 is consistent with the conceptual model for smolt migration presented in the FMP, but is simplified to identify the physical parameters affecting these life stages that will be monitored through the SJRRP. Table A-1 lists the studies associated with Smolt Survival.

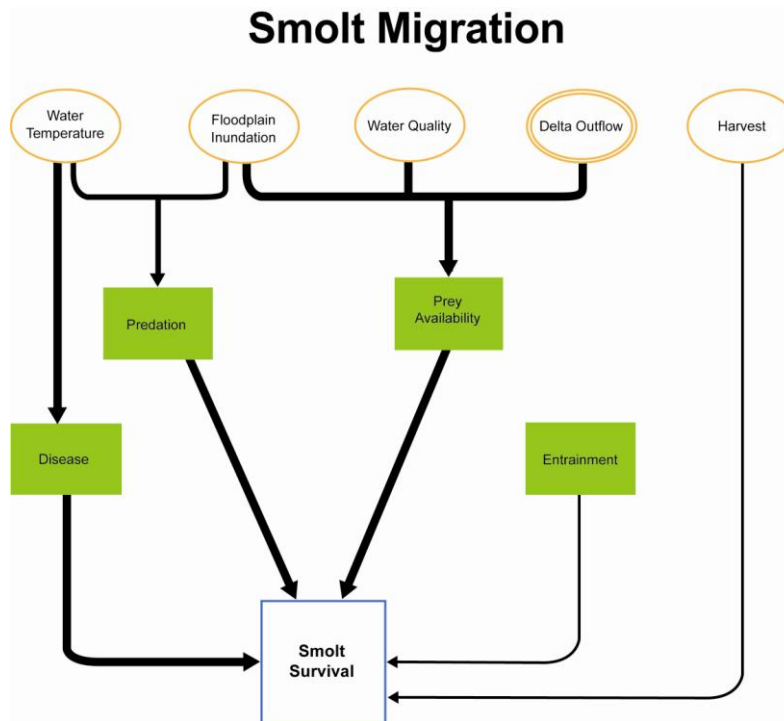

Note: The width of the arrows indicates the relative importance of each mechanism.

**Figure A-10. Physical Monitoring Parameters and Biological Impacts that May Affect Survival of Migrating San Joaquin River Spring-Run Chinook Salmon Smolts**

Successful rearing, smoltification, and outmigration will likely lead to a self-sustaining spring-run Chinook salmon population. Physical parameters that can be monitored having the greatest affect on outmigration include water temperature, water quality, and floodplain inundation. Delta outflow is also an important factor affecting rearing and outmigration; however, other programs are already monitoring Delta outflow. Therefore, the SJRRP would not conduct additional surveys, but would use existing data.

After reintroduction of Chinook salmon, monitoring the timing of smolt outmigration and smolt growth and physical condition would be related to ongoing monitoring of flow conditions, temperature, and food availability in Reaches 1 through 5 of the San Joaquin River. Management decisions related to Friant release schedules would consider the results from monitoring smolt outmigrants.

Monitoring the timing, growth, condition, and survival of smolt outmigrants will need to be related to the physiochemical environment. Determining the survival of smolts would be related to future adult return and straying rates, and is necessary for the permitting process.

Surveys to determine predator movements and feeding patterns would be related to ongoing monitoring of flow and water temperatures in Reaches 1 through 5 of the San Joaquin River. The information from these surveys would be used to determine smolt survival, and assist in efforts to increase survival, as necessary.

## 10.0 Problem Statement – Adult Recruits

*Identify limiting factors to adult recruits leading to a self-sustaining Chinook salmon population.*

The FMP identifies adult recruits as the outcome of the ocean survival life stage. Smolt that survive outmigration develop into adults in the ocean. Ocean productivity is determined by a complex set of ocean conditions and is the key impact to development of adult recruits. SJRRP cannot monitor or manage for any impacts to ocean survival, yet development of adult recruits is essential for the SJRRP to achieve the Restoration Goal. The SJRRP will rely on other studies for information, data, and trends of ocean productivity. Table A-1 lists the studies associated with Adult Recruits.

*This page left blank intentionally.*

## 11.0 Problem Statement- Adult Passage

*Identify limiting factors to adult passage leading to a self-sustaining Chinook salmon population.*

The FMP identifies adult passage as the outcome of the adult migration life stage. Adult recruits migrate into the Delta, past the lower portion of the San Joaquin River, and through the Restoration Area to the holding pools and spawning areas below Friant Dam. SJRRP thinks that disease and straying are the key biological impacts to adult passage, and water temperature, Delta outflow, Delta water quality, passage, and stream flow are the as the measureable, physical impacts controlling incidence of disease and straying. FMWG developed passage requirements (e.g., jump pool depth, velocity at screens, etc.) for adult salmon and other native fish which must be met at existing and future structures for successful adult passage.

Figure A-11 is consistent with the conceptual model for adult passage presented in the FMP, but is simplified to identify the physical parameters affecting this life stage that will be monitored through the SJRRP. Table A-1 lists the studies associated with Adult Passage.

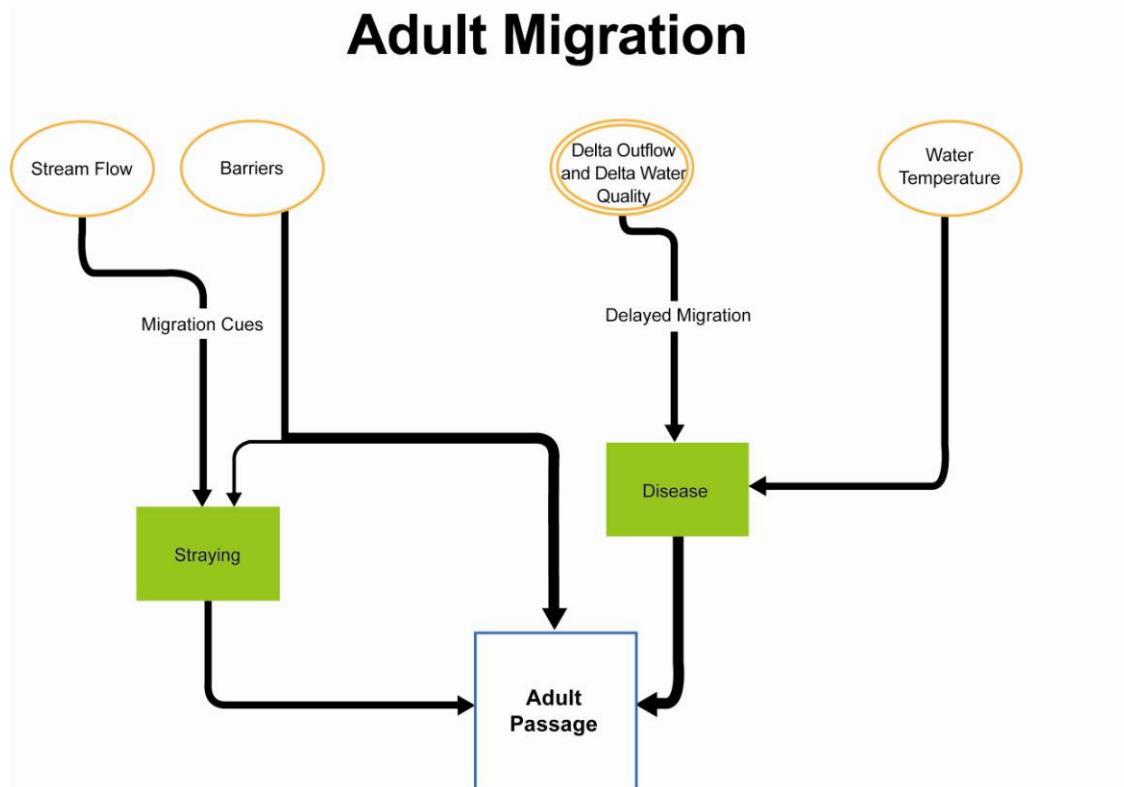

**Figure A-11. Physical Monitoring Parameters and Biological Impacts that May Affect Survival of Migrating San Joaquin River Spring-Run Chinook Salmon Adults**

Friant Dam release timing may be critical for returning adults as delivery of water constituents to the Delta serve as migration cues for fish to detect their natal stream. Delta water quality and outflow issues can also play a role in masking migration cues and result in delayed migration. Relationships between San Joaquin River streamflow, Delta water quality, Delta outflow, delayed migration, and migration cues are not well understood, but are thought to be an important part of successful adult passage. SJRRP may utilize monitoring data collected by other entities beyond the Restoration Area to evaluate physical impacts resulting in straying and disease during adult migration